

清洁技术+取样阀+视镜+照明技术
Clean technology+sample valve+sight glass+lighting technology



WWW.CNDONJOY.COM

国家高新技术企业 浙江省著名商标
www.cndonjoy.com



东正一直致力于重大技术进步，是您值得信赖的事业伙伴！
Donjoy committing to major technological advances, is your reliable business partner!

WWW.CNDONJOY.COM

0.1	自控调节阀+控制器 Automatic control regulating valve +Control head
0.2	生物制药隔膜阀 Biopharmaceutical diaphragm valve
0.3	高洁净泵 High purity pumps
0.4	防混蝶阀+蝶阀 Mixing proof butterfly valve +Butterfly valve
0.5	球阀 Ball valve
0.6	截止换向阀+防混阀+罐底阀 Divert seat valve+Mixing proof valve +Tank bottom valve
0.7	角座阀+截止阀 Angle seat valve+Globe valve
0.8	止回阀+恒压阀+安全阀+减压阀 Check valve+constant pressure valve+safety valve +air release valve
0.9	清洁技术+取样阀+视镜+照明技术 Clean technology+sample valve+sight glass +lighting technology
0.10	过滤器+人孔 Filter+man hole cover(manway)
0.11	卫生管件 Sanitary fittings ASME BPE DIN11852 Bs4825 SMS ISO IDF 3A



注意：
目录技术资料仅供设计参考，
设计更新和技术升级恕不另行通知！

不断革新的技术、日新月异的市场发展和客户需求是当今我们面临的巨大挑战。面对这些挑战我们信心十足，因为东正高度专业化的产品和技术创新，是我们未来将以更高、更优的产品来满足不断增长的市场需求。

Technological innovation, rapid development of the market and customer needs are the greatest challenges facing us today. Facing with these challenges we are confident, because of highly professional products and technological innovation, we will meet the growing demand of market and customer with our better and better products.

法律声明：
目录样册版本属东正所有，如有抄袭东正将追究其法律责任和经济赔偿。
东正众多技术设计，都具有专利保护，如有抄袭，东正必将追究法律责任和经济赔偿。

关于东正 About DONJOY



温州滨海经济开发区生产基地
Wenzhou binhai economic development zone production base

东正创立于1993年，注册资金5508万，是一家专注于研发高品质PID过程控制器、阀门定位器、流量控制器，阀门控制单元，高洁净过程控制阀、智能自控阀，高洁净泵、高洁净管材和管道配件。公司高度专业化的产品和技术专注于生物制药、食品饮料、酿酒、精细化工等工业领域。东正众多的创新解决方案，对满足全球，尤其是新兴市场不断增长生物制药和食品饮料行业的需求起到了积极作用。

东正制造的产品母材料、加工技术、焊接技术、表面处理等技术指标均已达到国内外先进水平。且符合ASME BPE、EHEDG、FDA、3A等一系列国际标准和规范要求，先后通过了由德国TÜV机构实施的欧盟承压设备指令(PED-97/23/EC)和(MD-06/42/EC)认证、美国3A机构实施的3-A卫生标准认证、中国安全阀特种制造设备(TS)许可证和中国质量认证中心CQC ISO9001:2008质量管理体系认证等多项国际权威认证。

东正凭借先进的技术、优异的品质和完善的售后服务体系，先后被评定为国家高新技术企业，省著名商标、省科技型企业、创新型企业、专利示范企业、研发中心企业，守合同重信用AAA企业等众多荣誉。

温州空港经济园区生产基地
Wenzhou airport economic zone production base

占地面积29000m²，总投资1.2亿元，该基地建成后预计年可实现销售额5亿元。生产基地，新引进ABB工业机器人、日本马扎克5轴加工中心、ABB机器人抛光设备。

Covering an area of 29000 m², with total investment after construction is expected to 120 million yuan, the base to achieve sales of 500 million yuan. Production base, introduces new ABB industrial robot, Japan mazar-e-sharif grams of five axis machining center, ABB machine Polishing equipment.

Donjoy was built up in 1993, with registered capital RMB 55,08 millions. We focus on developing high quality PID process controller, the valve positioner, the flow controller, the valve control unit, high purity process control valve, intelligent self-control valve, high purity pump, high purity tubing fitting and pipeline accessories. Donjoy's products and technologies are widely used in biopharmaceutical, food, drink, wine fine chemicals and other industrial fields. Donjoy's innovation solutions meet the growing demand of the industry of biopharmaceutical, food and beverage from the whole world, especially the emerging market.

Raw material, processing technology, welding technology, surface treatment from Donjoy have achieved advanced levels of domestic and foreign market. Donjoy productions according to ASME BPE, EHEDG, FDA and 3A standard, get certificate of PED-97/23/EC and MD-06/42/EC issued by TUV, 3A issued by 3A organization, TS licence and ISO9001:2008.

Donjoy with advanced technology, excellent quality and perfect after-sales service system, has been assessed as the national high-tech enterprises, the Provincial Famous Trademark, the Trovincial Science and Ttechnology Enterprises, Innovative Enterprises, Patent Model Enterprises, R & D Center, AAA Credit Enterprises.



制造与检验 Manufacturing and testing



机器人生产线

DONJOY以科学技术是第一生产力，也是企业核心竞争力，只有不断投入核心技术研发和创新，不断追求卓越，精益求精、以先进生产设备，严格的质量管理体系，精密的生产检测流程，保证每一款产品优良的性能。

Science and technology constitute a primary productive force, also the core competitive strength of the enterprise. Continuously intensifying the research, development and innovation of core technology, pursuing prominence and keeping improving, ensuring the excellent quality and performance of every single product by advanced production equipment, strict quality control and precise production and inspection procedures.

荣誉与资质

Honor and qualification

WWW.CNDONJOY.COM

	<p>3A</p> <p>东正是美国3A认证组织的成员，3A是一个自愿组织，致力于维护公共卫生和奶制品产品质量通过独特的行业监管程序的设备，用于处理乳制品的卫生标准3A认证。东正通过认证产品，阀门系列(54-02)证书号(1580)，泵系列(02-10)证书号(1579)，管件(63-03)证书号(1581)等多种规格型号。</p>
	<p>PED/97/23/EC & MD/06/42EC</p> <p>东正通过了TUV NORD欧共体压力设备97/23/EC质量保证模式H&材料(管件)制造认证。 阀门证书 NO.CE 0036 泵类证书 NO.705201402401-00</p>
	<p>FDA177.2600</p> <p>东正生产的阀门和泵以及流体设备等，与物料接触密封圈全部通过或符合美国食品和药品管理局和联邦法规第21条即，CRF 21 FDA177.2600和FDA177.1550认证，其涵盖： EPDM VITON(FPM) SILICON HNBRTFE橡胶塑料材料等。</p>
	<p>ISO9001/2008</p> <p>东正通过中国质量认证中心CQC，ISO9001-2008/GB/T19001-2008企业质量管理体系认证。其证书编号: 00108Q24215R1M/3302</p>
	<p>卫生许可证</p> <p>东正通过了省卫生厅卫生阀门、卫生管件等检验，且获得了其颁发的证书，其编号: So083。 其许可证为国家出台的生活饮用水卫生监督方法证书。</p>
	<p>高新技术企业</p> <p>东正通过多年发展和技术创新已获得了多项国家发明专利，100多项实用新型专利，现已成为国家高新技术企业。</p>
	<p>浙江省著名商标</p> <p>东正09年获得了温州市著名商标，2012年获得了浙江省著名商标。</p>

DONJOY不但拥有以上认证和荣誉，且被评定为省科技型、创新型、专利示范、研发中心、守合同守信用企业等众多的荣誉证书。



新一代360°旋转喷射器 Rotary jet head(360°)

主要特点 Features

喷射器是一种先进的灌清洗机应用于:

- ◆ 食品与乳制品
 - ◆ 制药
 - ◆ 化学处理
 - ◆ 运输设备
 - ◆ 饮料
- 优势
- ◆ 自清洗
 - ◆ 低液消耗
 - ◆ 卫生设计

The injector is a kind of advanced irrigation cleaner used in:

- ◆ The food and dairy products
 - ◆ Pharmaceutical
 - ◆ Chemical treatment
 - ◆ Transport equipment
 - ◆ Beverage
- Advantage
- ◆ Self-cleaning
 - ◆ Low liquid consumption
 - ◆ Hygienic design

工作原理 Operating principles

- ◆ 喷射器是卫生的水箱清洗机，提供360°覆盖范围在一个给定的罐或过程容器。喷射器是由流动的液体通过叶轮产生的动能。在压力和流量的增加会相应增加射流的长度和冲击力到罐或容器表面。
- ◆ 喷射器独特的自我清洗功能，内部被完全充分清洗。
- ◆ Rotary injector is hygienic tank cleaner, with 360° coverage in a given tank or process container. The rotary jet head is driven by flow liquid through impeller. In the pressure and flow increase will increase the length of the jet and the impact to the tank or vessel surface.
- ◆ Rotary injector with unique self cleaning function, internal is completely cleaning.

水箱清洗设备/安装方式 Tank cleaning equipment/Installation



典型应用 Typical application

- ◆ 固定安装CIP系统
- ◆ 过程容器和反应堆
- ◆ 储罐
- ◆ 运输灌设备
- ◆ 发酵
- ◆ 酵母繁殖
- ◆ Fixed installation CIP system
- ◆ Process containers and reactor
- ◆ Store tank
- ◆ Transport tank equipment
- ◆ Fermentation
- ◆ Yeast breeding

技术参数 Technical paramet

- ◆ 流量: 4-45m³
- ◆ 进口压力: 4-10bar
- ◆ 建议压力: 6bar
- ◆ 最高温度: 95°C
- ◆ 连接标准: 螺纹 BSP, 1.5"-DN40/1"DN25
- ◆ 卡箍DIN/INCH, 1.5"-DN40
- ◆ 材质: 316L/1.4404, 聚四氟乙烯
- ◆ 润滑: 清洗介质
- ◆ Flow: 4-45 m³
- ◆ inlet pressure: 4-10 bar
- ◆ Suggest pressure: 6 bar
- ◆ Max temperature: 95°C
- ◆ Connection: BSP, 1.5"- DN40/1"DN25
- ◆ Clamp DIN/INCH, 1.5"- DN40
- ◆ Material: 316L/1.4404, PTFE
- ◆ Lubrication: cleaning medium

性能曲线图 Performance curve

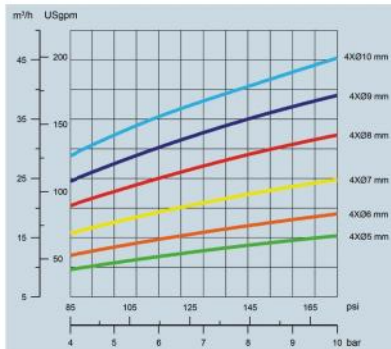

压力/流量曲线图
Pressure/flow Curve

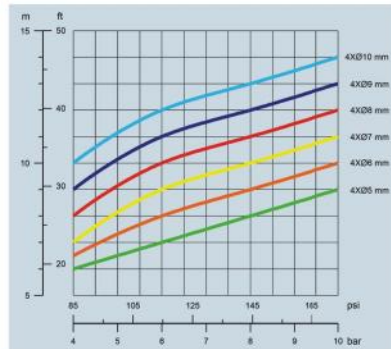

压力/射流长度曲线图
Pressure/jet length curve

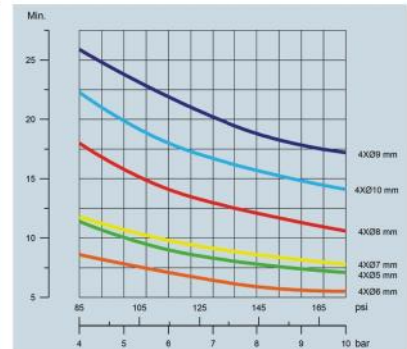

推荐清洗时间曲线图
Recommend cleaning time curve

规格参数 Specifications

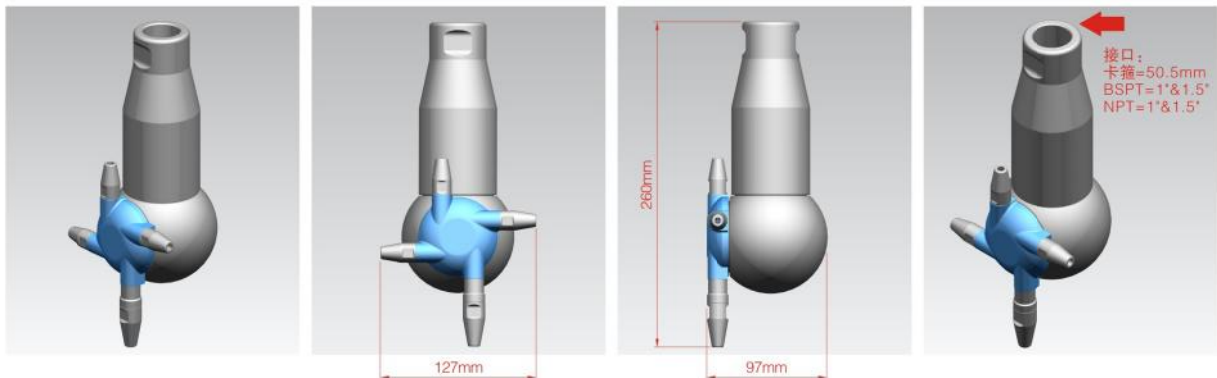

清洗器 Cleaner (spray ball)



360°

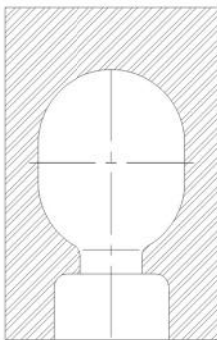

270°U

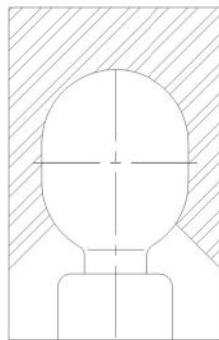

180°U

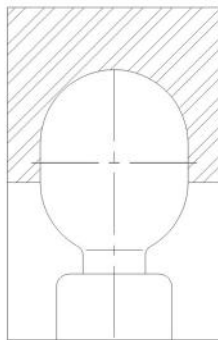

270°D

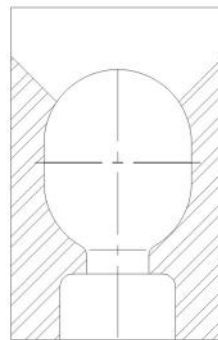

180°D

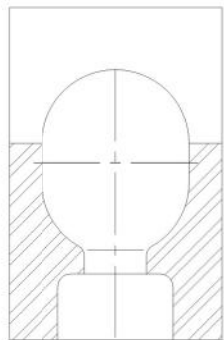

应用 Applications

- ◆清洗器系列产品主要应用在食品加工、饮料、啤酒制药工业领域等罐设备上，对罐内部进行强力的喷射和清洗。
- ◆固定清洗球：360度全部喷射、180度喷射、喷射孔径2.5mm
- ◆旋转清洗球：球状为椭圆形和圆形，喷射口为扁槽状型

- ◆Cleaner series products are mainly used to spray strongly and clean inside of tank, generally, in field of food-processing, beverage, beer, pharmaceutical industries.
- ◆Fixed cleaning Spray hole: 360 degree spray completely, 180 degree spray, aperture of spray is 2.5mm.
- ◆Rotary cleaning ball: ball is elliptical and spherical. Jet orifice is flat slot shape.

清洗球曲线图-Q28 Performance curve-Q28

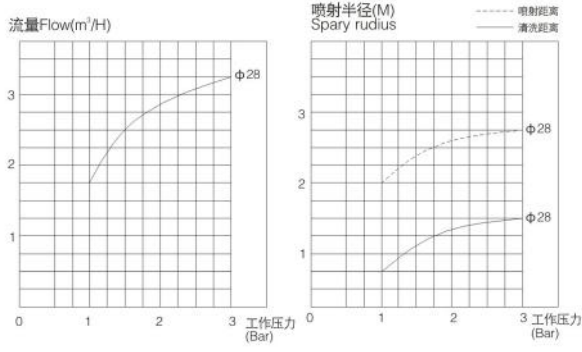

清洗球曲线图-Q45 Performance curve-Q45

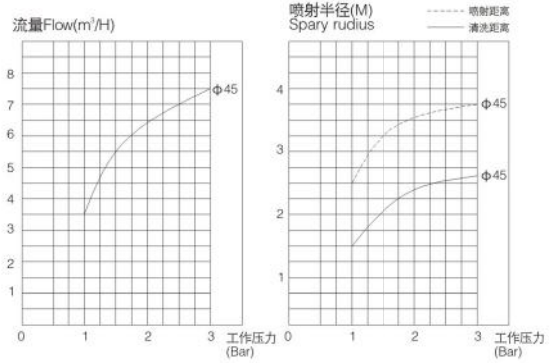

清洗球曲线图-Q65 Performance curve-Q65

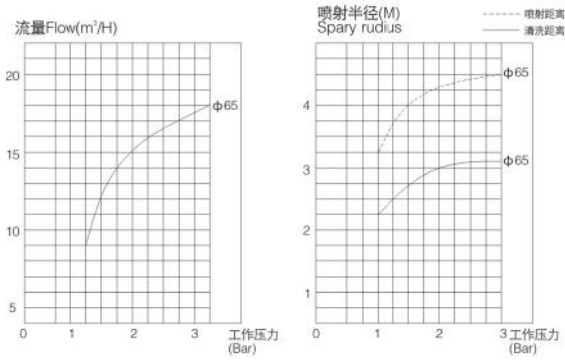

清洗球曲线图-Q75 Performance curve-Q75

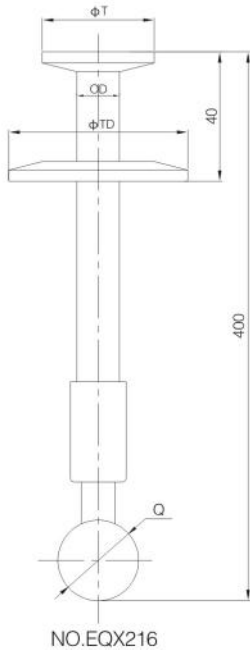
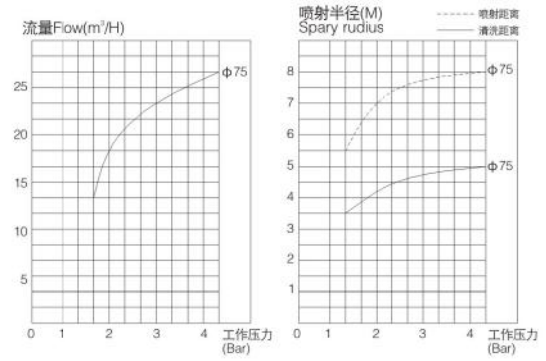

旋转清洗球(卡箍式)加长型
Rotary cleaning ball (clamped) Long type

Q	Size	OD	T	TD	2Bar压力		
					喷射半径(m) Spray radius	清洗半径(m) Cleaning radius	流量(m³/h) Flow rate
28	1/2"	12.7	25.4	77.5	2.5	1.1	2.5
45	1"	25.4	50.5	77.5	3.4	2.5	6.5
65	1.5"	38.1	50.5	91	4.2	3.1	15
75	2"	50.8	64	106	6.5	4.2	22

清洗器 Cleaner (spray ball)

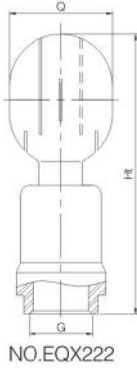

NO.EQX222

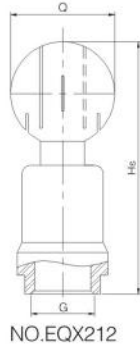

NO.EQX212

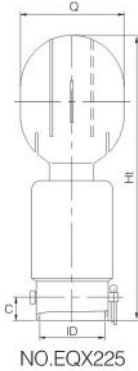

NO.EQX225

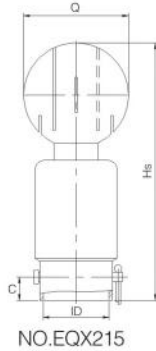

NO.EQX215

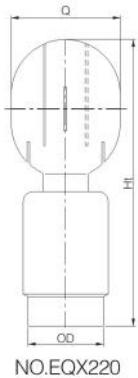

NO.EQX220

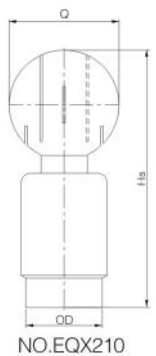

NO.EQX210

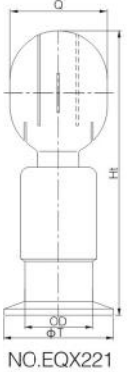

NO.EQX221

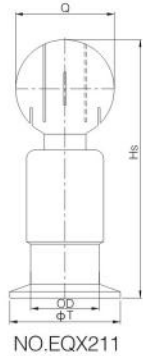

NO.EQX211

旋转清洗球(螺纹式) Rotary cleaning ball (threaded)

Q	G	Ht	Hs	2Bar压力		
				喷射半径(m) Spray radius	清洗半径(m) Cleaning radius	流量(m ³ /h) Flow rate
28	3/8"BSP	87.5	80.5	2.5	1.1	2.5
	1/2"BSP	90.5	83.5	2.8	1.2	2.8
	3/4"BSP	94.5	87.5	2.8	1.3	3.0
45	1/2"BSP	122.5	110.5	3.0	2.2	6
	3/4"BSP	126.5	114.5	3.4	2.5	6.5
	1"BSP	130.5	118.5	3.5	2.6	7.0
65	1"BSP	163.5	147.5	4.0	3.0	12
	1.25"BSP	165.5	149.5	4.2	3.1	15
	1.5"BSP	168.5	152.5	4.5	3.2	16
75	1.25"BSP	191.5	171.5	6.0	4.1	18
	1.5"BSP	194.5	174.5	6.5	4.2	22
	2"BSP	202.5	182.5	7.0	4.4	25

旋转清洗球(插销式) Rotary cleaning ball (Bolted)

Q	INCH		DIN		Ht	Hs	C	2Bar压力		
	Size	ID	Size	ID				喷射半径(m) Spray radius	清洗半径(m) Cleaning radius	流量(m ³ /h) Flow rate
28	1/2"	12.9	DN10	12.2	90.5	83.5	7	2.5	1.1	2.5
	3/4"	19.2	DN15	18.2	93.5	86.5	10	2.8	1.2	2.8
	1"	25.7	DN20	22.2	93.5	86.5	10	2.8	1.3	3.0
45	3/4"	19.2	DN20	22.2	128.5	116.5	10	3.0	2.2	6
	1"	25.7	DN25	28.3	128.5	116.5	10	3.4	2.5	6.5
	1.25"	32.1	DN32	34.3	128.5	116.5	10	3.5	2.6	7.0
65	1.25"	32.1	DN32	34.3	165.5	149.5	10	4.0	3.0	12
	1.5"	38.4	DN40	40.3	169.5	153.5	14	4.2	3.1	15
	2"	51.1	DN50	52.3	172.5	156.5	14	4.5	3.2	16
75	1.5"	38.4	DN40	40.3	197.5	177.5	14	6.0	4.1	18
	2"	51.1	DN50	52.3	197.5	177.5	14	6.5	4.2	22
	2.5"	63.8			201.5	181.5	14	7.0	4.4	25

旋转清洗球(焊接式) Rotary cleaning ball (welded)

Q	INCH		DIN		Ht	Hs	2Bar压力		
	Size	OD	Size	OD			喷射半径(m) Spray radius	清洗半径(m) Cleaning radius	流量(m ³ /h) Flow rate
28	1/2"	12.7	DN10	12	88.5	81.5	2.5	1.1	2.5
	3/4"	19	DN15	18	88.5	81.5	2.8	1.2	2.8
	1"	25.4	DN20	22	88.5	81.5	2.8	1.3	3.0
45	3/4"	19	DN20	22	124.5	112.5	3.0	2.2	6
	1"	25.4	DN25	28	124.5	112.5	3.4	2.5	6.5
	1.25"	31.8	DN32	34	124.5	112.5	3.5	2.6	7.0
65	1.25"	31.8	DN32	34	163	147	4.0	3.0	12
	1.5"	38.1	DN40	40	163	147	4.2	3.1	15
	2"	50.8	DN50	52	165	149	4.5	3.2	16
75	1.5"	38.1	DN40	40	192	172	6.0	4.1	18
	2"	50.8	DN50	52	192	172	6.5	4.2	22
	2.5"	63.5			193	173	7.0	4.4	25

旋转清洗球(卡箍式) Rotary cleaning ball (clamped)

Q	Size	OD	T	Ht	Hs	2Bar压力		
						喷射半径(m) Spray radius	清洗半径(m) Cleaning radius	流量(m ³ /h) Flow rate
28	1/2"	12.7	25.4	101.2	94.2	2.5	1.1	2.5
	3/4"	19	25.4	101.2	94.2	2.8	1.2	2.8
	1"	25.4	50.5	101.2	94.2	2.8	1.3	3.0
45	3/4"	19	25.4	137.2	125.2	3.0	2.2	6
	1"	25.4	50.5	137.2	125.2	3.4	2.5	6.5
	1.25"	31.8	50.5	137.2	125.2	3.5	2.6	7.0
65	1.25"	31.8	50.5	175.7	159.7	4.0	3.0	12
	1.5"	38.1	50.5	175.7	159.7	4.2	3.1	15
	2"	50.8	64	177.7	161.7	4.5	3.2	16
75	1.5"	38.1	50.5	204.7	184.7	6.0	4.1	18
	2"	50.8	64	204.7	184.7	6.5	4.2	22
	2.5"	63.5		205.7	185.7	7.0	4.4	25

固定式清洗球 Fixed cleaning ball

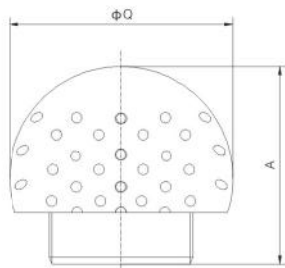

NO.EQX313

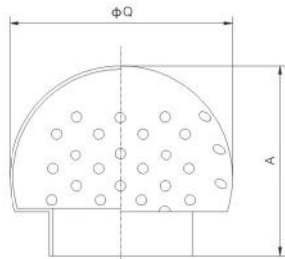

NO.EQX310

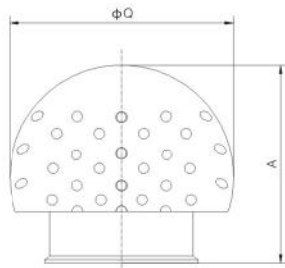

NO.EQX311

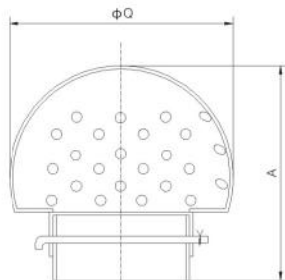

NO.EQX315

应用 Applications

- ◆固定清洗球:360度全部喷射、180度喷射、喷射孔径25mm。
- ◆Fixed cleaning ball:360 degree spray completely 180 degree spray aperlure of spray is 2.5mm.

螺纹式 Threaded

SIZE	Q	A	压力(bar) Pressure	喷射半径(m) Spray radius	流量(m ³ /H) Flow rate (360° /180°)
1"	63	72	2.5	1.0-1.25	17/10
1.25"	76	85	2.5	1.25-1.75	23/17
1.5"	76	85	2.5	1.25-1.75	23/17
2"	76	87	3.5	2.0-3.0	55/38
2.5"	91	102	3.5	3.0-3.5	58/41

焊接式 Welded

SIZE	Q	A	压力(bar) Pressure	喷射半径(m) Spray radius	流量(m ³ /H) Flow rate (360° /180°)
1"	53	72	2.5	1.0-1.25	17/10
1.5"	63	85	2.5	1.25-1.75	23/17
2"	91	87	3.5	2.0-3.0	55/38
2.5"	100	102	3.5	3.0-3.5	58/41

卡箍式 Clamped

SIZE	Q	A	压力(bar) Pressure	喷射半径(m) Spray radius	流量(m ³ /H) Flow rate (360° /180°)
1"	63	80	2.5	1.0-1.25	17/10
1.25"	76	93	2.5	1.25-1.75	23/17
1.5"	76	93	2.5	1.25-1.75	23/17
2"	91	108	3.5	2.0-3.0	55/38
2.5"	100	115	3.5	3.0-3.5	58/41

插销式 Bolted

SIZE	Q	A	压力(bar) Pressure	喷射半径(m) Spray radius	流量(m ³ /H) Flow rate (360° /180°)
1"	63	72	2.5	1.0-1.25	17/10
1.5"	76	85	2.5	1.25-1.75	23/17
2"	91	87	3.5	2.0-3.0	55/38
2.5"	100	102	3.5	3.0-3.5	58/41

气动截止阀+清洗球

Pneumatic globe valve + cleaning ball

技术特点

该清洗阀，主要解决了因清洗球长期泡在介质中形成的死角而容易细菌繁殖而污染介质。该阀门开启时清洗，关闭时保持清洗球与介质不接触，从而避免了死角。

Technical features

The flushing valve, mainly solved by cleaning ball long soak in the medium forming bacteria and dead easy contamination media. When the valve is opened to clean and maintain the cleaning medium is not in contact with the ball is closed, thus avoiding the dead angle.

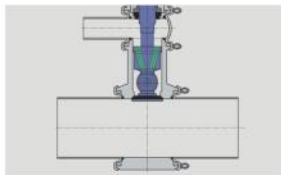

卡箍连接

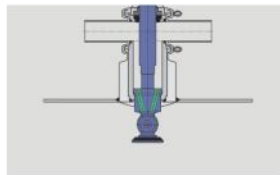

对焊连接

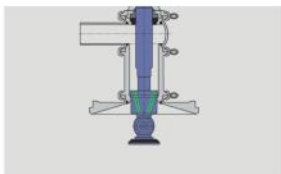

法兰连接

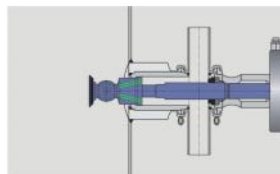

侧面焊接连接

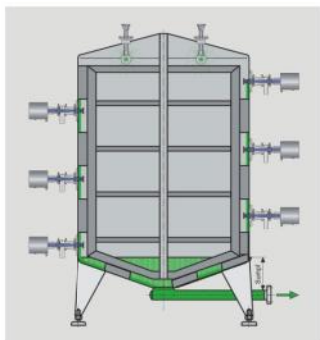

容器设备清洗示例

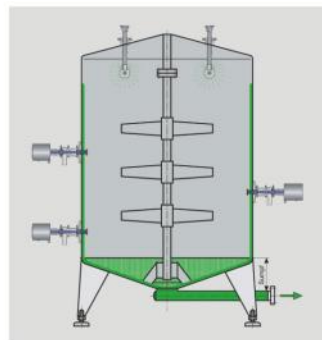

容器设备清洗示例

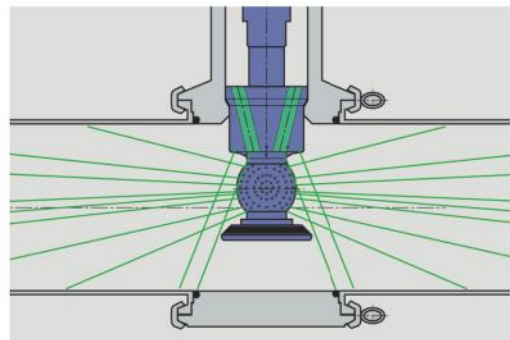

管道清洗示例

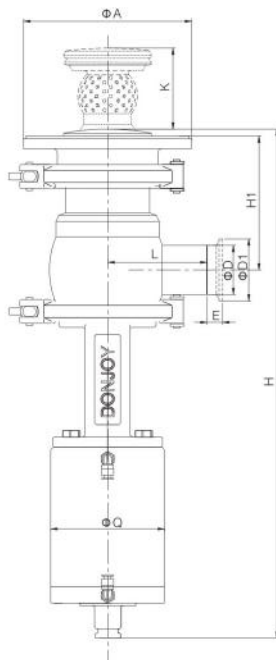

NO.VHX800Q1

DIN气动截止换向阀+清洗球
DIN Pneumatic Divert Seat Valve

SIZE	D	D1	Q	A	L	H1	H	K	E
DN25	28	50.5	88	130	70	98	433	53	12.7
DN40	41	50.5	88	130	80	104	443	53	12.7
DN50	52	64	113	150	80	111	476	53	12.7

INCH气动截止换向阀+清洗球
INCH Pneumatic Divert Seat Valve

SIZE	D	D1	Q	A	L	H1	H	K	E
1"	25.4	50.5	88	130	70	98	433	53	12.7
1.5"	38.1	50.5	88	130	80	104	443	53	12.7
2"	50.8	64	113	150	80	111	476	53	12.7

如您，需更大的规格请联系东正！
 Such as your need larger size, please contact the Theotokos!



无菌取样阀 Aseptic sampling valve

DONJOY创新设计
专利保护



工作原理 Operating principles

- ◆该无菌取样阀为每次取样前和取样后进行杀菌。
 - ◆开启阀门：取样-通过旋转手柄(可调整阀门)或通过拉动操作杆(开/关阀门)来开启手动操作的阀门。然后柄和隔膜缩回，允许液体通过。
 - ◆关闭阀门：消毒-通过相反的步骤，内置弹簧关闭阀门，保持软管间的通道开启，用于消毒。如果使用蒸汽，建议在出口装一个小型的压力安全阀。
 - ◆标准设计：该无菌取样阀由三个部分组成、阀体、手柄和隔膜阀。橡胶膜置于阀杆上，作为拉伸塞子。
 - ◆连接形式：螺纹、罐焊接、钢管焊接、卡箍。
 - ◆手柄形式：(1)旋转手柄(2)可移动钥匙。
 - ◆应用领域：该阀门用于啤酒、牛奶、饮料、果汁、制药等行业。
-
- ◆The aseptic sampling valve is designed for sterilization before and after each sampling.
 - ◆Open: Sampling-The manual valve is opened by rotating the handle(adjustable valve) or by activating the lever(on/off valve). The stem and the membrane are then retracted, allowing liquid to pass.
 - ◆Closed: Sterilizing-The built-in spring closes the valve and keeps the channel open between the hoses though reverse process in order to sterilize. If using by steam, a small pressure relief valve(optional) on the outlet is recommended.
 - ◆Standard Design: the aseptic sampling valve consists of three parts, a valve body, a handle and a membrane. The rubber membrane is placed on the stem of the valve and works as a stretchable plug.
 - ◆Connection: Thread, pipe welding, tank welding, Clamp.
 - ◆Handle: (1)Turning handle (2)removable key.
 - ◆Application: The aseptic sampling valve is applied to beer, milk, beverage, fruit juice, pharmacy industries tec.

材质 Material

- ◆ 阀体: AISI 316L ◆ Valve body: AISI 316L
- ◆ 手柄: AISI 304 ◆ Handle: AISI 304
- ◆ 膜片: EPDM PTFE ◆ Membrane: EPDM PTFE

技术规范

- ◆ 最大压力: 600kpa(6bar)

安装尺寸 Installation dimension

气动取样阀
Pneumatic sampling valve

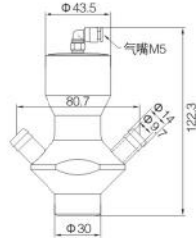

气动无菌取样阀
Pneumatic aseptic sampling valve
NO. VQY100Q1

特点:
取样后自动关闭阀门

Features:
Sampling valve automatically closed
after sampling

自动回位式取样阀
Automatic return type sampling valve

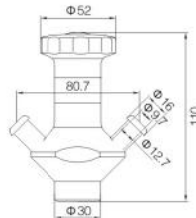

手动手轮无菌取样阀
Manual aseptic sampling valve
NO. VQY100S1

特点:
取样后自动复位

Features:
Automatic reset after sampling

扳手式取样阀
Turning handle type sampling valve

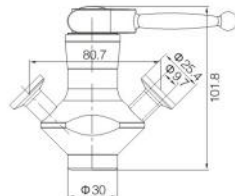

手动手柄无菌取样阀
Manual aseptic sampling valve
NO. VQY100S2

特点:
扳手式手柄每次取样后可将其取走防止意外发生

Features:
This type can be removed after each
sampling to avoid accident open.

温度 Temperature

- ◆ 最高温度: 130°C(EPDM) ◆ Max. Temperature: 130°C(EPDM)
- ◆ 最高温度: 150°C(PTFE) ◆ Max. Temperature: 150°C(PTFE)

Technical specification

- ◆ Max. Working pressure: 600kpa(6bar)

工作原理 Operating principles

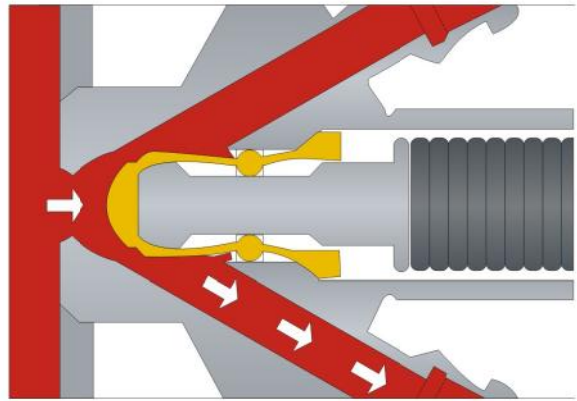

开启阀门, 取样
Open the valve, sampling

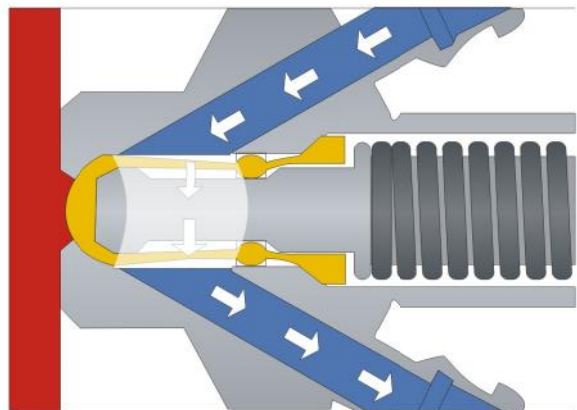

关闭阀门, 消毒
Close the valve, sterilizing

无菌取样阀 Aseptic sampling valve



取样阀+管路连接器
Sample valve+pipeline connector



取样阀+罐体连接器
Sample valve+tank connector



进出口+防护套
Sample valve+protective sleeve



气动无菌取样阀
Pneumatic aseptic sampling valve



钥匙手柄无菌取样阀
Lock handle sample valve



自动复位无菌取样阀
Auto reset sample valve



取样进出口选型
Interface selection:
◆软管Hoses
◆焊接Welding
◆卡箍Clamps
◆螺纹Thread
◆凸台口Boss Ends

罐体连接(焊接)
Welded connection
罐体连接(卡箍)
Clamp connection

各种配置阀体 Valve body with various configurations



密封圈
Gasket
◆EPDM
◆PTEE



流量微调阀头
Flow regulating valve head

气动阀头
Pneumatic valve head

自动复位阀头
Auto reset valve head

钥匙手柄阀头
Lock lever valve head

取样阀 Sample valve

应用 Applications

- ◆主要用于罐设备或管道里面的物料样品采集，也可安装在罐设备或管道的最低点用来排泄残留液。
- ◆its mainly applied to extract sample from tank or pipeline. It also can be assembled at the bottom of the tank or pipeline to drain away the remains.

操作原理 Operating principle

取样阀 Sample Valve

- ◆手轮顺时针旋转阀杆同密封圈抬起，此时阀门被开启取样，手轮逆时针旋转阀杆连同密封圈下降此时阀门被关闭。
- ◆when turn the hand wheel clockwise, the valve shaft and seal rise up. At this time, valve is open for sampling. When turn the hand wheel anti-clockwise, the valve shaft and seal go down, at that time, the valve is closed.



取样阀(椭圆式手轮) Sampling valve with elliptic type handle

技术参数 Technical specification

- ◆接口方式：螺纹、卡箍、焊接
- ◆最大压力：10bar 145psi
- ◆最小压力：真空
- ◆适用温度：-10°C/14° F 至120° F/248° F
- ◆阀体材质：AISI304/316L
- ◆密封材质：PTFE
- ◆Connections:thread, clamp, weld
- ◆Max. Pressure:10bar 145psi
- ◆Min. Pressure: vacuum
- ◆Temperature:-10°C/14° F to 120° F/248° F
- ◆Body material: AISI304/316L
- ◆Seal material: PTFE
- ◆O型圈：NBR
- ◆阀杆：AISI304/316L
- ◆卡簧：AISI304
- ◆O ring: NBR
- ◆Valve shaft: AISI 304/316L
- ◆Spring: AISI304

各种连接取样阀

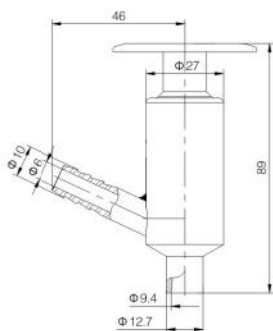

焊接式取样阀0.5"
Welded sampling valve 0.5"
NO.VQY200S1

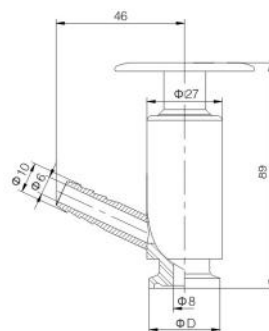

卡箍取样阀
Clamp
sampling valve
NO.VQY210S1

SIZE	D
1"	25.4
2"	50.5

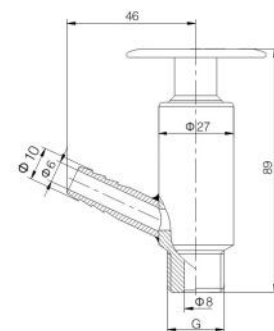

外螺取样阀
Male sampling valve
NO.VQY230S1

SIZE	G
1/4"	1/4"G-19
3/8"	3/8"G-19
1/2"	1/2"G-14
3/4"	3/4"G-14
1"	1"G-11

取样阀 Sample valve

直通式取样阀 Straight sampling valve

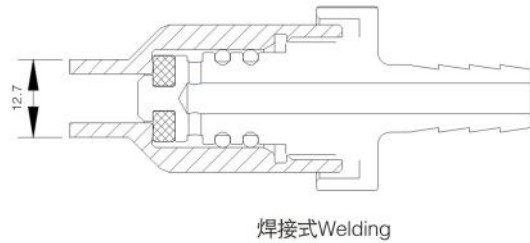
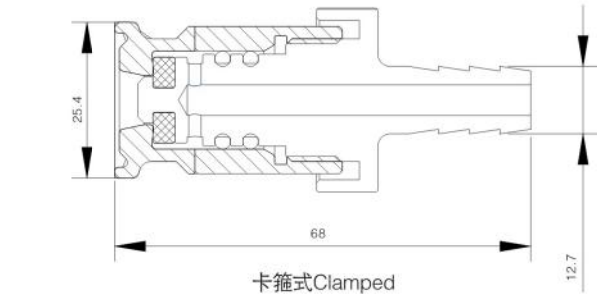

酸奶取样阀 Yogurt sampling valve

- ◆ 阀座开到罐内部或其他的设备内部，由此避免了因为管道过压造成阀门意外开启或泄漏等情况。
- ◆ 该阀门为常闭型(通过弹簧关闭)，用手一按手柄阀门开启，松开手柄门将自行关闭。
- ◆ 完全排水(液体)设计，防止了物料滞留阀门内部。
- ◆ The valve seat opens inside of tank or other equipment that it can avoid opening by accident due to high pressure in pipeline.
- ◆ The valve is normally closed(by spring). The valve is open as soon as pushing the handle and closed when loosing up.
- ◆ The design of completely drainage water is to avoid remains inside.

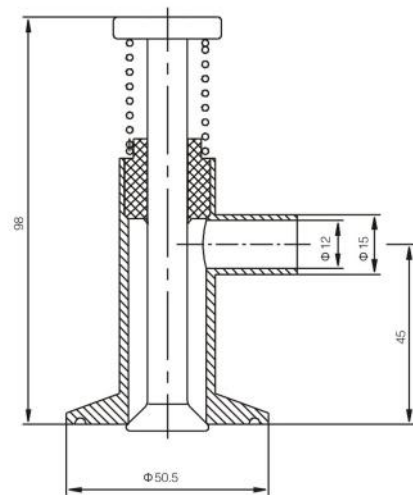
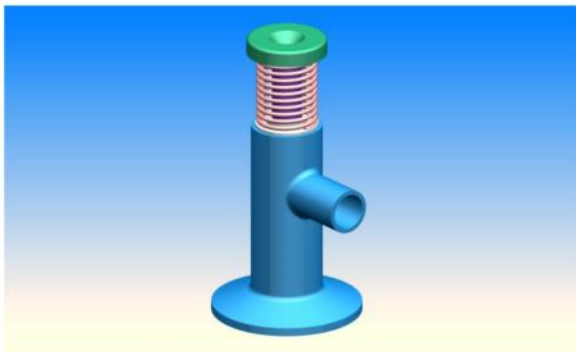

酸奶取样阀
Yogurt sampling valve
NO.VQY300S1

液体阀 Level gauge



应用 Applications

- ◆该液位计主要应用在罐设备上，两个不同或相同的液位计安装在罐设备上，可观察罐内液位情况或观察罐内容量，也可以直接取样。
- ◆规格：1/4"，3/8"，1/2"，3/4"
- ◆连接：螺纹、卡箍、焊接
- ◆认证：PED 97/23/EC, FDA 177.2600
- ◆The level gauge is mainly applied to the tank equipments. The two same gauges or two different gauges are assembled on the tank so that the liquid condition or capacity can be observed and the sample can be extracted.
- ◆Size: 1/4", 3/8", 1/2", 3/4"
- ◆Connections: thread, clamp, weld
- ◆Certificate: PED 97/23/EC, FDA 177.2600

技术参数 Technical specification

- ◆最大压力：10bar 145psi
- ◆最小压力：真空
- ◆适用温度：-10° F/14° F至120° F/248° F
- ◆阀体材质：AISI 304/316L
- ◆密封材质：PTFE
- ◆玻璃筒规格：Φ20
- ◆Max.pressure: 10bar 145psi
- ◆Min. Pressure: vacuum
- ◆Temperature: -10° F/14° F to 120° F/248° F
- ◆body material: AISI304/316L
- ◆Seal material: PTFE

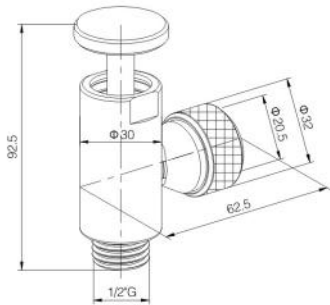
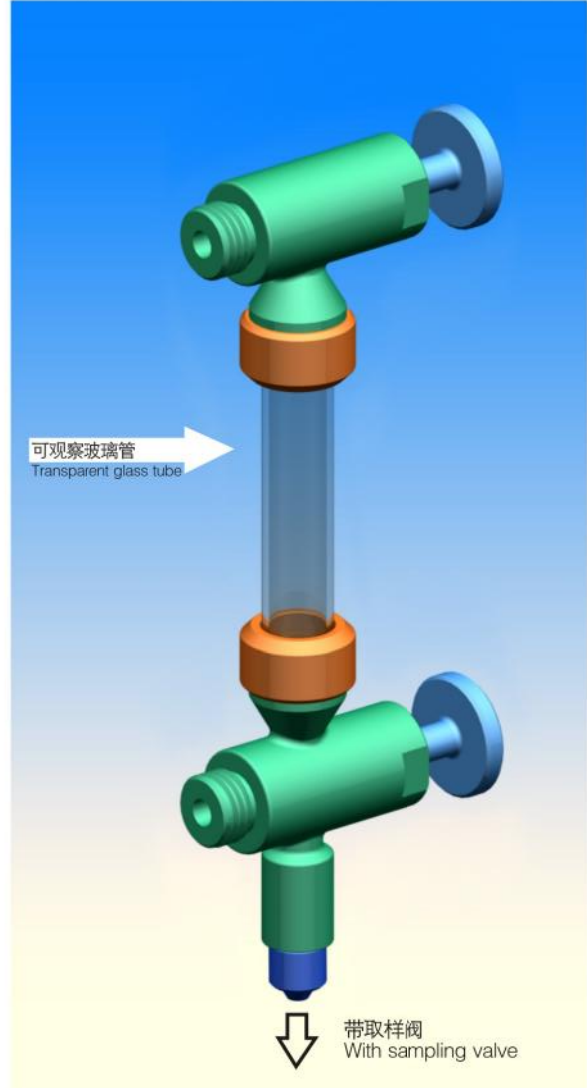

阀头液位计取样阀
Level Gauge(Superior)
NO.VQY430S1-01

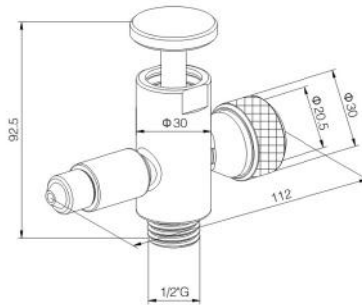

可视液位计取样阀
Level Gauge With Sample Valve
NO.VQY430S1

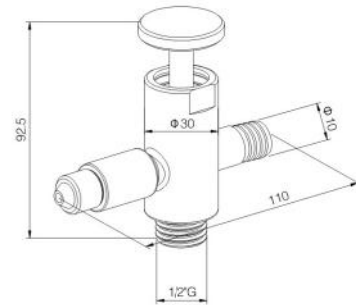

可视液位计取样阀(带软管)
Level Gauge With Sample Valve(With hose adaptor)
NO.VQY430S1-02



**DONJOY众多的灯视镜设计
专利保护**

东正众多的视镜系列，直通视镜、由任视镜、法兰视镜、视镜+照明、刮尘
DONJOY numerous sight glass series. Tubular sight glass, UNION sight glass, flange sight glass, sight glass+lighting, wiper

充锂电池照明
有线供电DC24V照明
有线供电AC110V、220V照明
不锈钢外壳
防水、防爆
IP67防护

Charging lithium battery lighting
Wired power supply DC24V lighting
Wired power supply AC110V/220V lighting
Stainless steel housing
Waterproof, explosion
IP67 protection



直通视镜 Tubular sight glasses

应用 Applications

- ◆直通视镜由不锈钢结构和玻璃组成。在食品加工，化妆品，制药和精细化工工业中，可以通过它清晰并且精确的观察到物料流动。
- ◆A tubular sight-glass is comprised of stainless steel frame and glass. Through it, operator can observe the flowing of the liquid substance clearly and precisely in the fields of food, cosmetics, pharmaceutical and fine chemicals industries.

设计和特点 Design and features

- ◆规格: DN25/1"到DN100/4" ◆Size: DN25/1" to DN100/4"
- ◆全通径设计 ◆Full bore design
- ◆360度观看角度 ◆360° viewing angle
- ◆可以垂直或水平使用 ◆Can be used in vertical or horizontal position

材质 Materials

- ◆保护套: AISI 304 ◆Protective sleeve: AISI 304
- ◆玻璃: 钢化玻璃 ◆Glass: tempered glass
- ◆垫圈: VMQ FDA 177.2600 ◆Gasket: VMQ FDA 177.2600
- ◆表面处理: CNC车床 ◆Surface treatment: CNC lathe

技术规格 Technical specifications

- ◆工作温度: -10°C到120°C ◆Working temp: -10°C to 120°C (Silicone)
- ◆最大操作压力(bar) ◆Max. Operating pressure (bar) as following

DIN	25	32	40	50	65	80	100
PYREX玻璃glass	10	10	10	8	8	8	8

选项 Options

- ◆垫圈材质: NBR、EPDM、FPM所有都根据FDA177.2600
- ◆连接: 焊接、卡箍、法兰、螺纹
- ◆标准: IDF, BS, RJT, SMS, DIN
- ◆Gasket material: NBR, EPDM, FPM in accordance with FAD177.2600
- ◆Connection: weld, clamp, flange, thread
- ◆Standard: IDF, BS, RJT, SMS, DIN

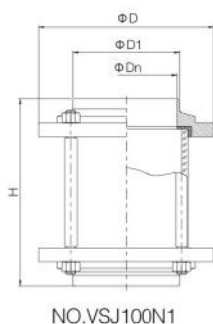

不锈钢防护罩
Stainless steel protective cover

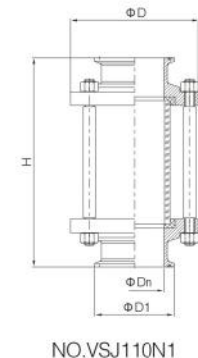

INCH

SIZE	H	D	D1	Dn
1/2"	140	78	12.7	9.4
3/4"	140	78	19.1	15.8
1"	140	78	25.4	22.4
1 1/4"	140	78	31.8	28.8
1 1/2"	140	86	38.1	35.1
2"	142	102	50.8	47.8
2 1/2"	146	115	63.5	59.5
3"	146	124	76.2	72.2
3 1/2"	150	139	89	85
4"	156	154	101.6	97.6
5"	170	185	133	127
6"	180	215	147	153

DIN

SIZE	H	D	D1	Dn
DN10	140	78	13	10
DN15	140	78	18	15
DN20	140	78	22	19
DN25	140	78	28	25
DN32	140	86	34	31
DN40	140	90	40	37
DN50	142	102	52	49
DN65	146	124	70	66
DN80	150	139	85	81
DN100	156	154	104	100
DN125	170	185	129	125
DN150	180	215	154	150

INCH

SIZE	H	D	D1	Dn
1/2"	156	78	25.4	9.4
3/4"	156	78	25.4	15.8
1"	156	78	50.5	22.4
1 1/4"	156	78	50.5	28.8
1 1/2"	160	86	50.5	35.1
2"	166	102	64	47.8
2 1/2"	170	115	77.5	59.5
3"	174	124	91	72.2
3 1/2"	174	139	106	85
4"	196	154	119	97.6
5"	212	185	144.4	127
6"	236	215	183	153

DIN

SIZE	H	D	D1	Dn
DN10	156	78	34	10
DN15	156	78	34	15
DN20	156	78	34	19
DN25	156	78	50.5	25
DN32	156	78	50.5	31
DN40	160	86	50.5	37
DN50	166	102	64	49
DN65	174	120	91	66
DN80	174	134	106	81
DN100	196	154	119	100
DN125	212	185	144.4	125
DN150	236	215	167	150
DN200	256	285	217.4	200

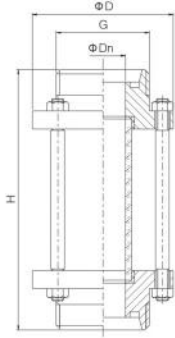

NO.DIN-VSJ130N1

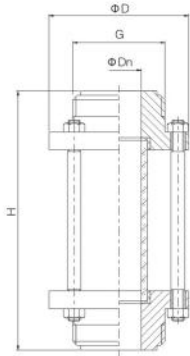

NO.IDF-VSJ130N1

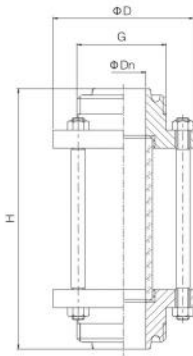

NO.RJT-VSJ130N1

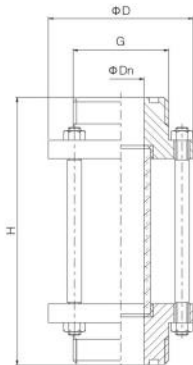

NO.SMS-VSJ130N1

DIN螺纹DIN thread

SIZE	H	G	D	Dn
DN10	156	RD28 × 1/8	78	10
DN15	156	RD33.5 × 1/8	78	15
DN20	156	RD43.5 × 1/6	78	19
DN25	156	RD51.5 × 1/6	78	25
DN32	160	RD57.5 × 1/6	86	31
DN40	164	RD64.5 × 1/6	90	37
DN50	166	RD77.5 × 1/6	106	49
DN65	170	RD94.5 × 1/6	124	66
DN80	174	RD109.2 × 1/4	139	81
DN100	196	RD129.2 × 1/4	159	100
DN125	220	RD159.2 × 1/4	185	125
DN150	240	RD189.2 × 1/4	215	150

ISO/IDF螺纹ISO/IDF thread

SIZE	H	G	D	Dn
1"	162	37.1 × 1/8Acme	78	22.4
1 1/2"	166	50.6 × 1/8Acme	86	35.1
2"	172	64.1 × 1/8Acme	102	47.8
2 1/2"	176	77.6 × 1/8Acme	115	60.5
3"	180	91.1 × 1/8Acme	128	72.2
4"(ISO)	202	118.2 × 1/8Acme	154	97.6
4"(IDF)	202	125.9 × 1/6Acme	154	97.6

RJT螺纹RJT thread

SIZE	H	G	D	Dn
1"	170	45.7 × 1/8TWHIT	78	22.2
1 1/2"	170	58.4 × 1/8TWHIT	86	34.9
2"	174	72.7 × 1/6TWHIT	102	47.6
2 1/2"	174	85.4 × 1/6TWHIT	115	60.3
3"	174	98.1 × 1/6TWHIT	128	73.0
4"	196	123.8 × 1/6TWHIT	154	97.5

SMS螺纹SMS thread

SIZE	H	G	D	Dn
3/4"	156	RD35.5 × 1/8	78	16
1"	156	RD39.5 × 1/6	78	22.4
1 1/4"	156	RD47.5 × 1/6	78	28.8
1 1/2"	160	RD59.5 × 1/6	86	35.1
2"	166	RD69.5 × 1/6	102	47.8
2 1/2"	170	RD84.5 × 1/6	115	59.5
3"	174	RD97.2 × 1/6	128	72.2
3 1/2"	176	RD104.2 × 1/6	139	85
4"(小)	196	RD124.2 × 1/4	154	97.6
4"(大)	196	RD131.2 × 1/4	159	97.6

新一代无菌、无死角视镜 Aseptic and no Zero-dead Angle sight glass(New type)



NEW



应用 Applications

- ◆直通视镜由不锈钢结构和玻璃组成。在食品加工，化妆品，制药和精细化工工业中，可以通过它清晰并且精确的观察到物料的流程。
- ◆A tubular sight-glass is comprised of stainless steel frame and glass. Through it, operator can observe the flowing of the liquid substance clearly and precisely in the fields of food, cosmetics, pharmaceutical and fine chemicals industries.

技术规格 Technical specifications

- ◆工作温度: -10°C到120°C
- ◆Working temp: -10°C to 120°C
- ◆最大操作压力(bar)
- ◆Max. Operating pressure (bar) as following

DIN	25	32	40	50	65	80	100
PYREX玻璃glass	10	10	10	8	8	8	8

设计和特点 Design and features

- ◆规格: DN25/1"到DN100/4"
- ◆Size: DN25/1" to DN100/4"
- ◆全通径设计
- ◆Full bore design
- ◆360° 观察
- ◆360° observation
- ◆可任意角度安装
- ◆Can be installed at any angle

材质 Materials

- ◆保护套: AISI 304
- ◆Protective sleeve: AISI 304
- ◆玻璃: 钢化玻璃
- ◆Glass: tempered glass
- ◆垫圈: EPDM FDA 177.2600
- ◆Gasket: EPDM FDA 177.2600
- ◆液体接触: ASME 316L/304

视窗玻璃
Sight glass

防护套
Protect sleeve



NEW



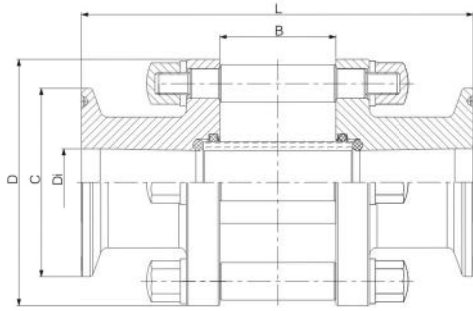

NO.VSJ610N1

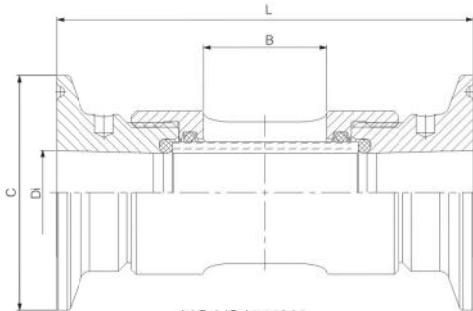

NO.VSJ610N2

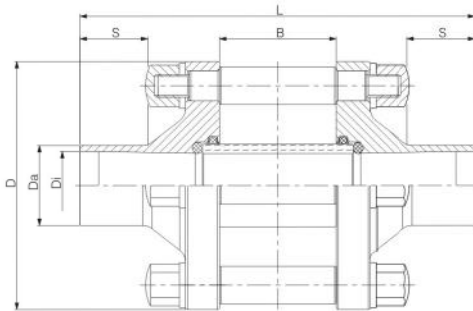

NO.VSJ600N1

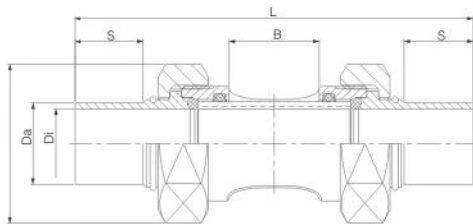

NO.VSJ600N3

Orifice	D (mm)	C (mm)	Di (mm)	B (mm)	L (mm)
BS-OD Dimensions Inline flow indicator with Clamp connection / full view version					
DN1"	73.00	50.50	22.10	36.00	105.00
DN1 1/2"	82.00	50.50	34.80	37.00	105.00
DN2"	100.00	64.00	47.50	54.00	140.00
DN2 1/2"	124.00	77.50	60.20	67.00	151.00
DN3"	135.00	91.00	72.90	97.00	181.00
DN4"	159.00	119.00	97.38	119.00	206.00

Orifice	D (mm)	C (mm)	Di (mm)	B (mm)	L (mm)
DIN Dimensions Inline flow indicator with Clamp connection / full view version					
DN25	80.00	50.50	26.00	32.00	105.00
DN32	80.00	50.50	32.00	32.00	105.00
DN40	90.00	50.50	38.00	41.20	121.00
DN50	100.00	64.00	50.00	67.00	140.00
DN65	130.00	91.00	66.00	67.00	158.00
DN80	145.00	106.00	81.00	110.00	196.00
DN100	160.00	119.00	100.00	97.00	184.00

Orifice	C (mm)	Di (mm)	B (mm)	L (mm)
DIN Dimensions Inline flow indicator with Clamp connection / standard				
ASME DN1/4"	25.00	4.6	20.00	76.00
ASME DN3/8"	25.00	7.75	20.00	76.00
ASME DN1/2"	25.00	9.40	20.00	76.00
ASME DN3/4"	25.00	15.75	30.00	92.00
ASME DN1"	50.50	22.10	30.00	92.00
ASME DN1 1/2"	50.50	34.80	32.00	115.00
ASME DN2"	64.00	47.50	48.00	120.00

Orifice	C (mm)	Di (mm)	B (mm)	L (mm)
DIN Dimensions Inline flow indicator with Clamp connection / standard				
DN08	25.00	8.00	20.00	76.00
DN10	34.00	10.00	20.00	76.00
DN15	50.50	16.00	30.00	92.00
DN20	50.50	20.00	30.00	92.00
DN25	50.50	26.00	32.00	92.00
DN32	50.50	32.00	32.00	92.00
DN40	64.00	38.00	32.00	120.00
DN50	64.00	50.00	48.00	120.00

Orifice	D (mm)	Da (mm)	Di (mm)	L (mm)	S (mm)	B (mm)
BS-OD Dimensions Inline flow indicator with weld end / full view version						
ASME DN1"	73.00	25.40	22.10	149.00	38.10	36.00
ASME DN1 1/2"	82.00	38.10	34.80	152.00	38.10	36.00
ASME DN2"	100.00	50.80	47.50	190.00	38.10	54.00
ASME DN2 1/2"	124.00	63.50	60.20	222.00	38.10	67.00
ASME DN3"	135.00	76.20	72.90	241.00	38.10	97.00
ASME DN4"	159.00	101.60	97.40	263.00	38.10	119.00

Orifice	D (mm)	Da (mm)	Di (mm)	L (mm)	S (mm)	B (mm)
DIN Dimensions Inline flow indicator with weld end / full view version						
DN25	73.00	29.00	26.00	115.00	18.00	36.00
DN32	82.00	35.00	32.00	115.00	18.00	36.00
DN40	82.00	41.00	38.00	125.00	20.00	41.20
DN50	100.00	53.00	50.00	156.00	20.00	65.00
DN65	124.00	70.00	66.00	158.00	20.00	67.00
DN80	145.00	85.00	81.00	207.00	20.00	97.00
DN100	160.00	104.00	100.00	214.00	25.00	118.40

Orifice	D (mm)	Da (mm)	Di (mm)	L (mm)	S (mm)	B (mm)
BS-OD Dimensions Inline flow indicator with weld end / standard						
ASME DN1/4"	21.94	6.35	4.60	92.00	18.00	20.20
ASME DN3/8"	25.40	9.50	7.70	107.30	25.10	21.00
ASME DN1/2"	31.18	12.70	9.40	107.00	25.40	18.00
ASME DN3/4"	36.95	19.05	15.75	120.00	25.10	20.00
ASME DN1"	48.30	24.40	22.10	121.00	25.40	30.00
ASME DN1 1/2"	62.00	38.10	34.80	136.00	25.40	32.00
ASME DN2"	80.00	50.80	47.50	161.50	25.40	48.00

Orifice	D (mm)	Da (mm)	Di (mm)	L (mm)	S (mm)	B (mm)
DIN Dimensions Inline flow indicator with weld end / standard						
DIN DN08	25.40	10.00	8.00	92.50	18.00	17.00
DIN DN10	31.18	12.00	10.00	92.00	18.00	18.00
DIN DN10	31.18	13.00	10.00	92.50	18.00	18.00
DIN DN15	36.95	19.00	16.00	110.00	18.00	20.00
DIN DN20	48.30	23.00	20.00	110.00	18.00	28.00
DIN DN25	48.00	29.00	26.00	110.00	18.00	24.00
DIN DN32	62.00	35.00	32.00	114.50	18.00	24.00
DIN DN40	62.00	41.00	38.00	122.50	18.00	31.00
DIN DN50	80.00	53.00	50.00	154.50	18.00	54.00

新一代四通视镜、零死角、零滞留

Four-way sight glass, zero dead angle, no retention

充电式灯视镜
Rechargeable battery



基本型
Standard type



接线供电灯视镜
Connection cable



不锈钢外壳, DC24V供电
Stainless steel Shell, DC 24V

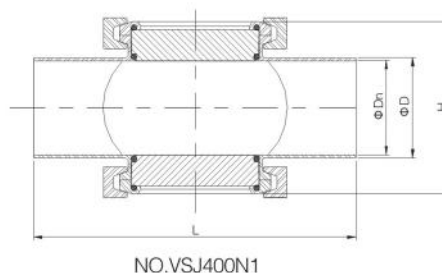
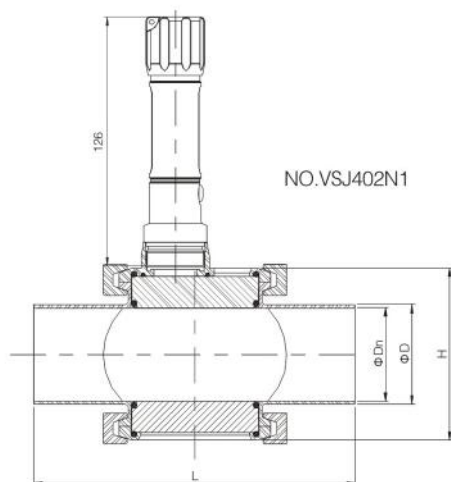

WWW.CNDONJOY.COM

应用 Applications

- ◆四通视镜由不锈钢结构和钢化玻璃组成。在食品加工，化妆品，制药和精细化工工业中，可以通过它清晰并且精确的观察到物料的流程。
- ◆Four-way sight glass is comprised of stainless steel frame and tempered glass. Through it, operator can observe the flowing of the liquid substance clearly and precisely in the fields of food, cosmetics, pharmaceutical and fine chemicals industries.

设计和特点 Design and features

- ◆规格从1"-4"到DN25-DN100玻璃通过卡箍安装到机构上
- ◆连接: 螺纹、卡箍、焊接、DIN、SMS、IDF
- ◆垫圈材质: EPDM NBR 符合FDA177.2600
- ◆材质: AISI 304(1.4301) AISI 316L(1.4404)
- ◆基本型最高温度: -10°C – 150°C
- ◆基本型+视镜灯: -10°C – 80°C (取决于灯耐温)
- ◆Size: 1"-4" to DN25-DN100 the glass can be installed on the equipment through clamps.
- ◆Connection: weld, clamp, thread, DIN, SMS, IDF
- ◆Gasket material: NBR, EPDM, FPM in accordance with FAD177.2600
- ◆Material: AISI304(1.4301) AISI316L(1.4404)
- ◆Max temperature(Basic): -10°C – 150°C
- ◆Max temperature (Basic with clamp): -10°C – 80°C (depending on light heat resistance)

技术优势 Technical advantage

- ◆无滞留、零死角、强光、白色冷光源、防水、防爆设计
- ◆有线供电AC110V/220V、DC24V
- ◆无线供电，一次充电可使用2-3月(根据频率而定)
- ◆No retention, zero dead angle, high light, white cold light source, waterproof, explosion-proof.
- ◆Cable power supply AC110V/220V, DC24V
- ◆Wireless power supply, one charging can be used 2-3 months (Depending on the frequency)

DIN四通视镜 DIN four-way glass

SIZE	D	Dn	H	L
DN40	40	37	75.1	165
DN50	52	49	87.8	165
DN65	70	66	108	218
DN80	85	81	123	250
DN100	104	100	141.6	300

INCH四通视镜 INCH four-way glass

SIZE	D	Dn	H	L
1 1/2"	38.1	35.1	75.1	165
2"	50.8	47.8	87.8	165
2 1/2"	63.5	59.5	101.5	205
3"	76.2	72.2	114.2	230
4"	101.6	97.6	141.6	300

法兰视镜

Flanged sight glass

不锈钢外壳, DC24V供电
Stainless steel shell, DC24V power supply



充电/有线供电, 灯法兰视镜
Charging/cable power supply, flange sight glass with lamp



技术优势 Technical advantage

- ◆ 强光、白色冷光源/防水、防爆设计
- ◆ 有线供电AC110V-220V、DC24V
- ◆ 无线供电, 一次充电可以使用2-3个月(根据频率而定)

- ◆ High light, white cold light source/waterproof, explosion-proof design.
- ◆ Cable power supply AC110V-220V, DC24V
- ◆ Wireless power supply, one charging can use 2-3 months (Depending on the frequency)

应用 Applications

- ◆ 法兰视镜由不锈钢结构和钢化玻璃组成。在食品加工, 化妆品, 制药和精细化工行业中, 可以通过它清晰并且精确的观察物料流动。
- ◆ Flanged sight glass is comprised of stainless steel frame and glass. Through it, operator can observe the flowing of the liquid substance clearly and precisely in the fields of food, cosmetics, pharmaceutical and fine chemicals industries.

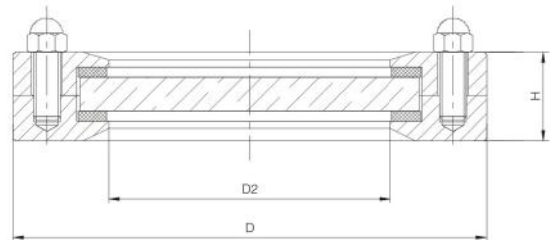

NO.VSJ200N1

设计和特点 Design and features

- ◆ 规格从1.5"-8"到DN40-DN200
- ◆ 通过内六角螺栓将两片法兰及玻璃装配在一起
- ◆ 垫圈材质: PTFE 符合FDA177.1600
- ◆ 材质: AISI 304(1.4301) AISI 316L(1.4404)
- ◆ 最大温度: -10°C到+120°C
- ◆ 最大压力: 10bar
- ◆ Size: 1.5"-8" to DN40-DN200
- ◆ Assemble flange with glass by using hexagon socket bolts
- ◆ Gasket material: PTFE in accordance with FAD 177.1600
- ◆ Material: AISI304(1.4301) AISI316L(1.4404)
- ◆ Max. Temperature: -10°C to +120°C
- ◆ Max. Pressure: 10bar

法兰视镜 Flange dsight glass

SIZE	H	D	D2
DN40	25	115	68
DN50	29	140	78
DN65	29	155	98
DN80	29	155	98
DN100	30	190	128
DN125	33	224	154
DN150	41	250	183
DN200	45	310	233

由任视镜 Union-type-sight-galss



卡箍由任式视镜
Clamp union-type-sight-glass

应用 Applications

- ◆带有透明的圆形玻璃，螺纹管口处有焊颈。
- ◆观看口用于观看生物反应器，实验室搅拌器、过滤器、处理容器、管道和其他关闭的容器。尤其适合于制药，食品和饮料加工，比如要酿酒厂、牛奶厂。
- ◆Union-type-sight-glass DIN11851/SMS (standard for dairy products), with transparent circular glass. Threaded nozzle with the welded neck.
- ◆It is used viewing the biologic reactor, blender in laboratory, fitter, processing container, pipeline and other closed container. Especially apply in pharmacy, food and beverage processing, such as the brewery, dairy.

材质 Materials

- ◆密封圈：EPDM FPM
- ◆与物料接触部位：1.4301(304); 1.4404(316L)
- ◆Seal: VEPDM FPM
- ◆The parts contact with liquid: 1.4301(304); 1.4404(316L)

操作条件 Operational term

- ◆压力：真空-10bar
- ◆温度：-10℃ / 130℃
- ◆Pressure: Vacuum -10bar
- ◆Temperature: Max.-10℃ / 130℃

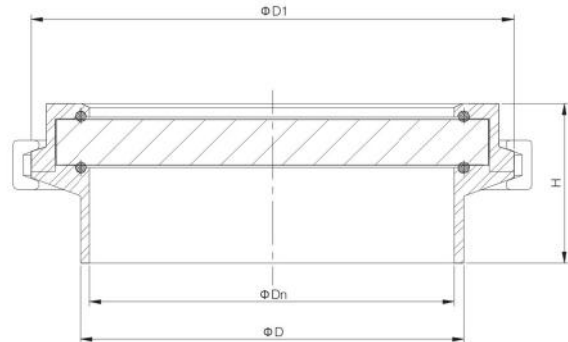

NO.VSJ500N1

DIN卡箍由任视镜 DIN Clamp union sight glass

SIZE	D	Dn	D1	H
DN40	40	37	50.5	35.5
DN50	52	49	64	35.5
DN65	70	66	91	35.5
DN80	85	81	106	35.5
DN100	104	100	130	37.5

INCH卡箍由任视镜 INCH Clamp union sight glass

SIZE	D	Dn	D1	H
1.5"	38.1	35.1	50.5	35.5
2"	50.8	47.8	64	35.5
2.5"	63.5	59.5	77.5	35.5
3"	76.2	72.2	91	35.5
4"	101.6	97.6	130	37.5

由任视镜+照明 Union-type-sight-galss + lighting

技术特点 Technical features

- ◆压力：真空-10bar
- ◆温度：-10°C至150°C，由任+照明-10°C至80°C
- ◆材质：304(1.4301) 316L(1.4404)

- ◆Pressure: Vacuum 10bar
- ◆Temperature: -10°C to 150°C, Union+lighting-10°C to 80°C
- ◆Materials: 304(1.4301) 316L(1.4404)



由任视镜+照明+刮尘
Union sight glass + lighting + scraper

- ◆DN80-DN150, 4"-6"
- ◆一次充电使用2-3个月
(根据使用频率而定)
- ◆AC220V/110V
- ◆防水、防爆、卫生设计
- ◆DN80-DN150, 4"-6"
- ◆One charge can be used for 2-3 months
(depending on frequency of use)
- ◆AC220V/110V
- ◆Waterproof, explosion-proof,
hygienic design



由任视镜+照明
Union sight glass+ Lighting

- ◆DN65-DN150, 3"-6"
- ◆一次充电使用2-3个月
(根据使用频率而定)
- ◆AC220V/110V
- ◆防水、防爆、卫生设计
- ◆DN65-DN150, 3"-6"
- ◆One charge can be used for 2-3 months
(depending on frequency of use)
- ◆AC220V/110V
- ◆Waterproof, explosion-proof,
hygienic design



由任视镜+照明+刮尘
Union sight glass + Stainless
steel lighting +The wiper

- ◆DN80-DN150, 4"-6"
- ◆供电DC24V
- ◆防水、卫生设计
- ◆预制电缆2M
- ◆预制针孔插头
- ◆DN80-DN150, 4"-6"
- ◆Powered DC24V
- ◆Waterproof hygienic design
- ◆Precast cable 2M
- ◆Precast pinhole plugs



由任视镜+不锈钢照明
union sight glass + stainless
steel lighting

- ◆DN65-DN150, 3"-6"
- ◆供电DC24V
- ◆防水、卫生设计
- ◆预制电缆2M
- ◆预制针孔插头
- ◆DN65-DN150, 3"-6"
- ◆Powered DC24V
- ◆Waterproof hygienic design
- ◆Precast cable 2M
- ◆Precast pinhole plugs



由任视镜+无电缆照明+刮尘
Union sight glass illumination +
without cable lighting+The wiper

- ◆DN80-DN150, 4"-6"
- ◆5号干电池A/A/1.5V
- ◆DN80-DN150, 4"-6"
- ◆No.5 battery A / A / 1.5V



由任视镜+无电缆照明
union sight glass + without
cable lighting

- ◆DN65-DN150, 3"-6"
- ◆5号干电池A/A/1.5V
- ◆DN65-DN150, 3"-6"
- ◆No.5 battery A / A / 1.5V

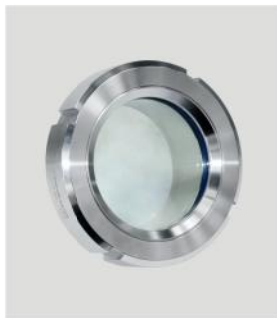

基本由任视镜
Basic union sight glass

- ◆DN25-DN150, 1"-6"
- ◆材质：304/316L
- ◆DN25-DN150, 1"-6"
- ◆Material: 304 / 316L



由任视镜+刮尘
Sight glass + The wiper

- ◆DN50-DN150, 2"-6"

由任视镜 Union-type-sight-galss

由任视镜+充电照明
sight glass Rechargeable Lighting

供电: AC220V/110V
一次充电可使用2-3个月
(使用频率而定)

Powered: AC220V/110V
On a single charge be used for
2-3 months (depending on
frequency of use)

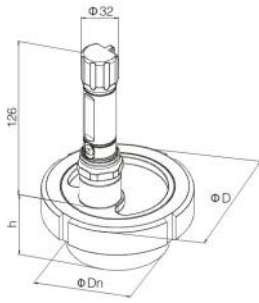

NO.VSJ302N1

由任视镜+不锈钢照明
sight glass + stainless steel lighting

DC24V
预制电缆2M
预制针孔插头 (选项)

DC24V
Precast cable 2M
Precast pinhole plugs (option)

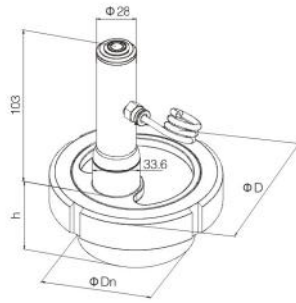

NO.VSJ303N1
由任视镜+照明

由任视镜+不锈钢照明
sight glass + stainless steel lighting

5号干电池

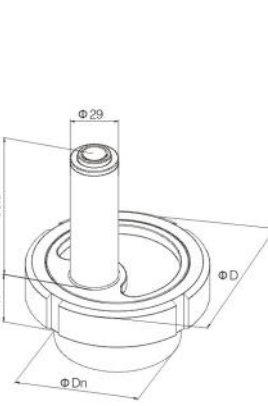

NO.VSJ301N1
由任视镜+照明

DIN

SIZE	D	Dn	h
DN50*	92	55	38
DN65	110	72	44
DN80	125	87	49
DN100	146	106	57
DN125	178	132	52
DN150	210	157	53

INCH

SIZE	D	Dn	h
2**	82	50.8	30
2.5*	110	63.5	30
3*	125	76.2	33
4*	146	101.6	34
-	-	-	-
6*	210	152.4	53

注意: 带 "*" 只适用于由任视镜+不锈钢外壳
照明, 使5号干电池
Note: Above size with "*" only suitable for
union-type sight glass with SS lighting(NO.5 battery)

由任视镜+充电照明+刮尘
sight glass Rechargeable
Lighting+The wiper

供电: AC220V/110V
一次充电可使用2-3个月
(使用频率而定)

Powered: AC220V/110V
On a single charge be
used for 2-3 months
(depending on frequency
of use)

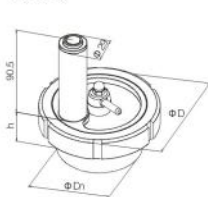

NO.VSJ301Y1

由任视镜+不锈钢照明+刮尘
sight glass + stainless steel
lighting+The wiper

DC24V
预制电缆2M
预制针孔插头 (选项)

DC24V
Precast cable 2M
Precast pinhole plugs (option)

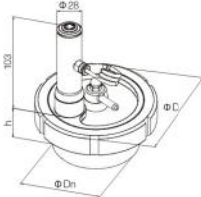

NO.VSJ303Y1

由任视镜+不锈钢照明+刮尘
sight glass + stainless steel
lighting+The wiper

5号干电池

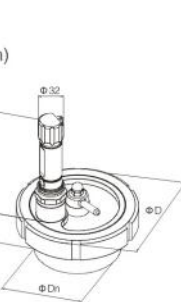

NO.VSJ302Y1

由任视镜+刮尘
sight glass + The wiper



NO.VSJ300Y1

DIN

SIZE	D	Dn	h
DN50*	92	55	45
DN65*	110	72	48
DN80	125	87	53
DN100	146	106	63
DN125	178	132	57
DN150	210	157	62

INCH

SIZE	D	Dn	h
2**	92	50.8	33
2.5**	110	63.5	37
3**	125	76.2	37
4*	146	101.6	40
-	-	-	-
6*	210	152.4	62

注意: 带 "*" 只适用于由任视镜+尘刮
Note: Above size with "*" only
suitable for union-type sight glass with wi per

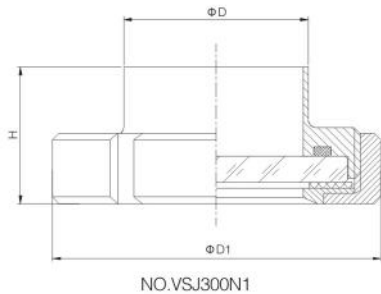

NO.VSJ300N1

DIN

SIZE	D	D1	H
DN25	28	63	26.5
DN32	34	70	26
DN40	40	78	26
DN50	52	92	28
DN65	70	110	29
DN80	85	125	32
DN100	104	146	36
DN125	129	178	40
DN150	154	210	46

INCH

SIZE	D	D1	H
1"	25.4	50	24.5
1 1/4"	31.8	60	26
1 1/2"	38.1	72	28
2"	50.8	82	28
2 1/2"	63.5	97	32
3"	76.2	111	32
3 1/2"	89.0	118	33
4"	101.6	138	36
6"	152.4	210	45

多角度视镜灯/工业照明/防水/防爆/卫生设计

Multi-angle sight glass/industrial lighting/water proof/explosion-proof /hygenic design

技术特点 Technical features

- ◆304外壳、强光、白色冷光源、防水、防爆设计
- ◆DC 24V
- ◆预制电缆2M，预制插头 2 针
- ◆开关指示灯



多角度照明视镜灯 Multi-angle Lighting

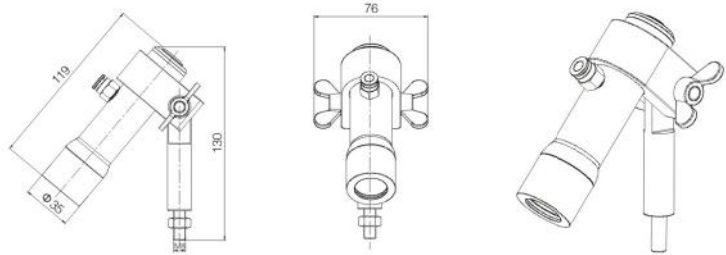

NO.EZM320

- ◆304 shell, high light white cold light source/waterproof, explosion-proof design.
- ◆DC 24V
- ◆Precast cable 2M, precast plugs 2 core pinhole
- ◆Switch indicator

技术特点 Technical features

- ◆强光、白色冷光源、防水、防爆设计
- ◆有线AC 220V/110V
- ◆无线供电，一次充锂电池可使用2-3个月(根据使用频率而定)



多角度照明视镜灯 Multi-angle Lighting

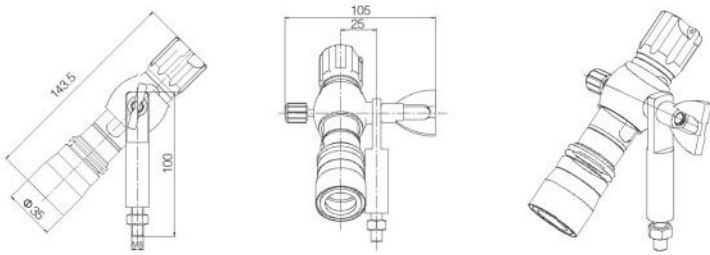

NO.EZM220

- ◆High light, white cold light source/waterproof, explosion-proof design.
- ◆Cable power supply AC110V-220V, DC24V
- ◆Wireless power supply, one charging can use 2-3 months (Depending on the frequency)



卡箍视镜灯 Clamp Lighting

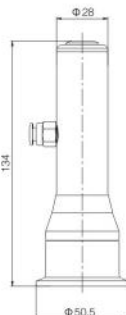

NO.EZM311



焊接灯视镜 Welding Lighting

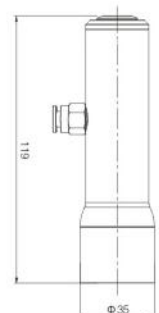
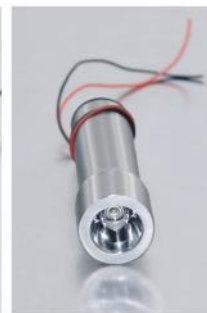

NO.EZM310



CHINA DONJOY TECHNOLOGY CO.,LTD.

DONJOY looking forward to your visit! Your telecommunications!

WWW.CNDONJOY.COM



中国·东正 科技有限公司

地址: 温州空港经济技术开发区
温州滨海经济技术开发区
总机: 0577-86990888
传真: 0577-86998000

Add: Wenzhou airport economic and
technological development zone
Wenzhou binhai economic and
technological development zone
Tel: +86-577-86990888
Fax: +86-577-86998000
E-mail: donjoy@cndonjoy.com

www.cndonjoy.com

法律声明:

目录样册版本属东正所有, 如有抄袭东正将追究其法律责任和经济赔偿。
东正众多技术设计, 都具有专利保护, 如有抄袭, 东正必将追究法律责任和经济赔偿。